

Data Sheet



Article number: 604133034085

Description: Taper bored timing belt pulley
HTD 34 14M 85 TL 2517

Measures

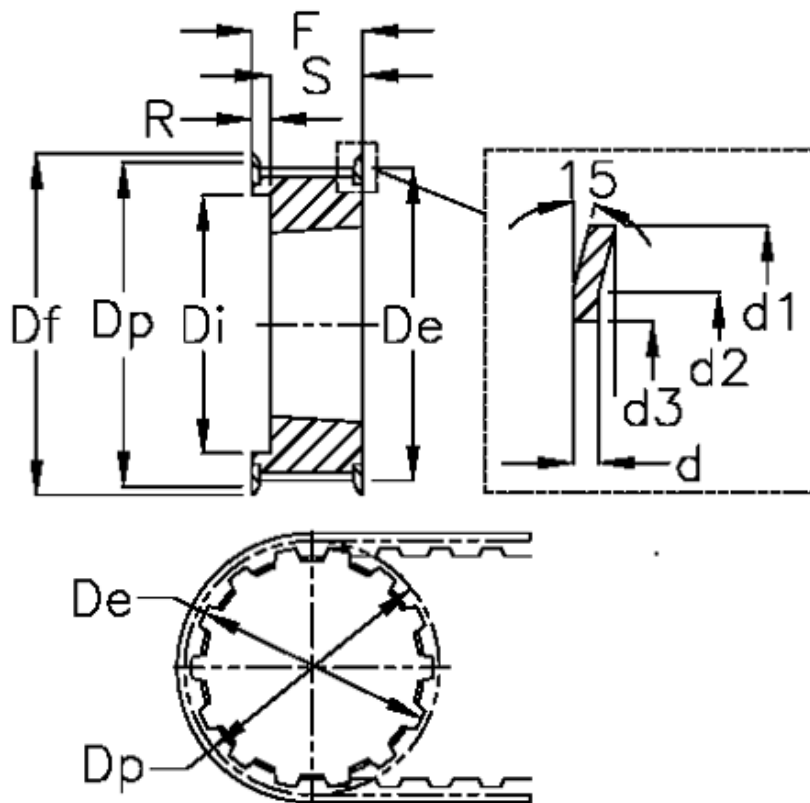

$d = 2.5$	F = 102	Weight = 6
$d1 = 160$	Flange type = F51	Width = 85
$d2 = 148$	For bushing = 2517	
$d3 = 120$	Max bore = 60	
$De = 148.79$	r = 28.5	
$Df = 160$	S = 45	
$Di = 110$	Tooth number = 34	
$Dp = 151.52$	Type = 14M	